

# 信号区

用户按键

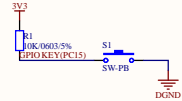

POWER

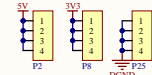

PB6-PB9

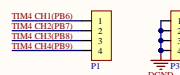

PA15-PB5

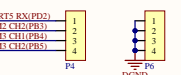

PC10-PD2

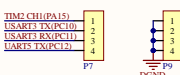

PA11-PA14

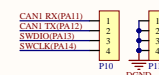

PC9-PA10

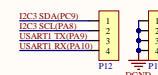

PB14-PC7



状态指示

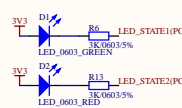

PC13-NRST

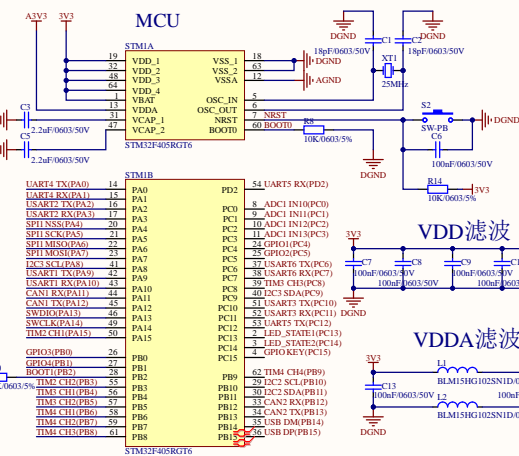

CAN1 Transceiver

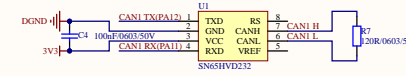

CAN扩展板接口

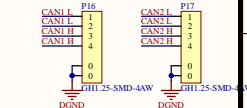

RGB指示

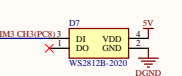

PC0-PC3

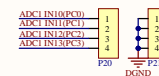

VDD滤波

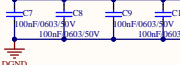

VDDA滤波



CAN2 Transceiver

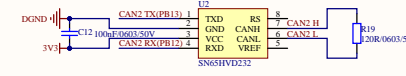

上拉电阻

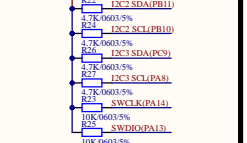

BOOT选择



PA0-PA3

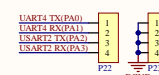

PA4-PA7

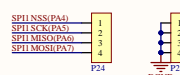

PC4-PB1

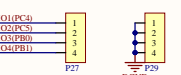

PB10-PB13

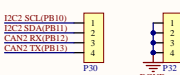

USB Terminator

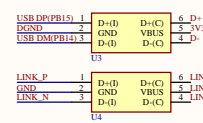

USB保险丝

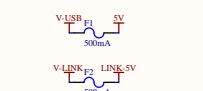

USB接口

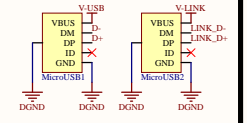

# 电源区

DCDC+LDO

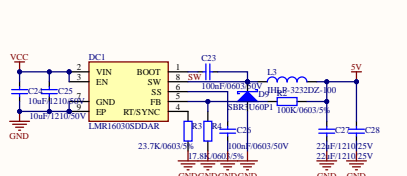

ST-LINK

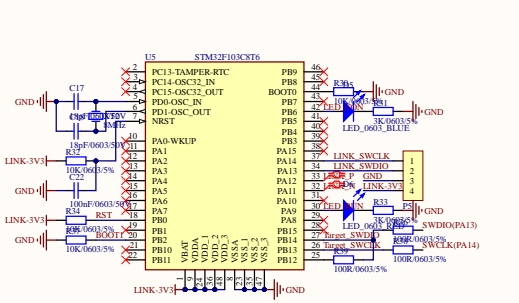

UART1-6接口

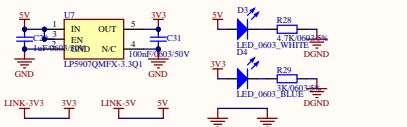
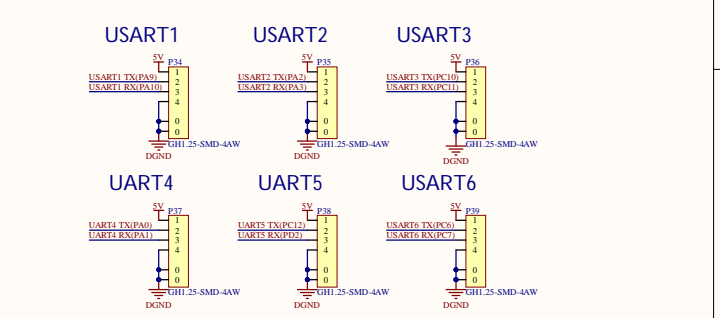

Title		HWSD-DEV Series-F405	
Size	Number	Revision	
A2		V1.0	
Date:	21/8/2022	Sheet of	
File:	C:\Users\HWSD-Develop\SCH\SchDoc\Drawn By:	ASR-Czsh	